

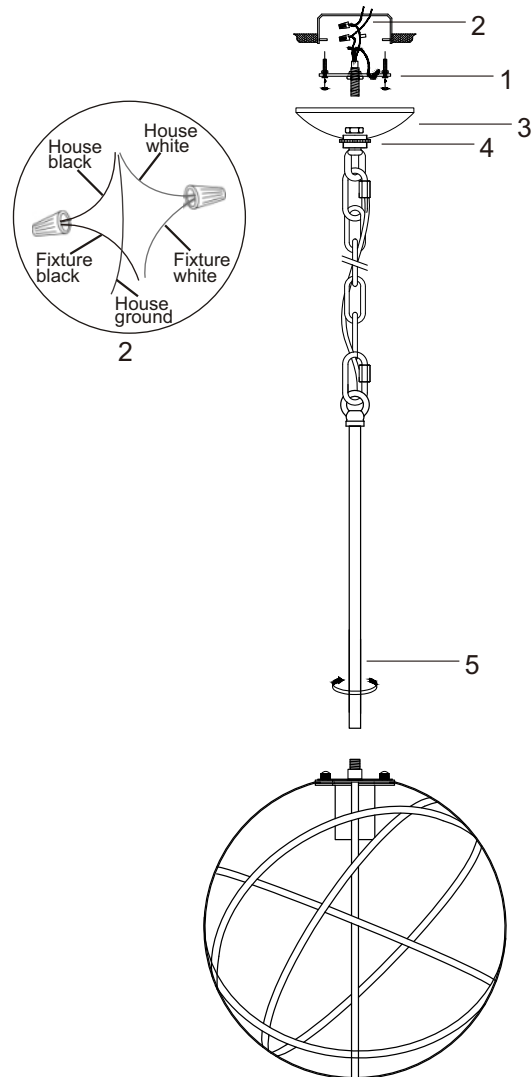

# C57801BK



## INSTALLATION INSTRUCTIONS:

- Ensure main supply is switched off.
- Fit mounting bracket (1) onto outlet box with self-tapping screws.
- Connect wires (2) according to color (White to White, Black to Black). Connect all earth lug together onto the crossbar with green screw to tight.
- Move ceiling cup (3) onto mounting bracket with chain ring (4).
- Screw pole (5) onto lamp shade.
- Install lamps firmly into lampholders.
- Reconnect power.

## WARNING:

- This fitting must be earthed.
- Disconnect power and allow fitting to cool down before cleaning or changing the lamp.